

ATX™ UPR Series 16 Amp Plugs and Sockets

Increased Safety

ATEX/IECEX:
Zone 1 and 2 - 21 and 22
⊕ II 2 GD
IP66 - IK09

Applications

- Plugs and receptacles are used with portable or stationery electrical equipment such as:
 - Lighting systems
 - Conveyors
 - Heaters
 - Motor generators
 - Air conditioning equipment
 - Compressors
 - Pumps
- For use in corrosive atmospheres and installations in Zone 1 and 2 and 21 and 22 of the oil and gas industry; such as:
 - Refineries
 - Chemical and petrochemical plants
 - Pipelines
 - Loading docks
 - Onshore and offshore drilling platforms

Features

- Plug and socket system is designed with a mechanical interlock to insure disengagement cannot occur while energized.
- Large ON/OFF actuator on the receptacle gives clear, visible indication of the receptacle status for maximum hazardous location protection.
- Low Voltage receptacle can be locked in 0 (Off) and 1 (On) positions.
- Different voltages are color coded for easy identification.
- The receptacles are keyed to accept UPR plugs of the proper voltage.
- Receptacle explosionproof switch.
- UPR plugs can be used in non-hazardous IEC 60309-2 sockets.
- Operating temperature of -20 °C to +55 °C (-4 °F to +131 °F)

Standard Materials

- Wall Socket: polyamide
- Plug: polyamide

ATEX/IECEX Certifications and Compliances

- Certification Type UPR
 - Gas: Zones 1 and 2
 - Conforming to ATEX 94/9/CE: ⊕ II 2 G
 - Type of Protection: Ex db eb IIB
 - Temperature Class: T6 for $T_a \leq +40$ °C (+104 °F) and T5 for +55 °C (+131 °F)
 - Dust: Zones 21 and 22
 - Conforming to ATEX 94/9/CE: ⊕ II 2 D
 - Type of Protection: Ex tb IIIB
 - Surface Temperature: T79 °C [$T_a + 40$ °C (+104 °F)]; T94 °C [$(T_a + 55$ °C (+131 °F)]
- Ambient Temperature: -20 °C $\leq T_a \leq$ +55 °C (-4 °F $\leq T_a \leq$ +131 °F)
- Index of Protection according EN/IEC 60529: IP66
- Impact Resistance (shock): IK09
- CE Declaration of Conformity: 50311
- ATEX Certificate: LCIE 15 ATEX 3054X
- IECEx Certificate: IECEx LCIE 15.0044X



Wall Mounting Socket



Plug

Technical Data

Breaking Capacity		
AC1	16 Amp	690 Vac
AC3	8 Amp	500 Vac
	4 Amp	690 Vac
AC15	16 Amp	690 Vac
	10 Amp	415 Vac
DC1	10 Amp	24 Vdc
	6 Amp	50 vdc

Short Circuit Withstand (ICC) : 10kA

ATX™ UPR Series 16 Amp Plugs and Sockets

Increased Safety

ATEX/IECEX:
Zone 1 and 2 - 21 and 22
II 2 GD
IP66 - IK09



Wall Mounting Socket (LV)

- Two M25 threaded entries on the bottom. Available on top upon request.
- Supplied with one M25 cable gland – Ø 8 to Ø 18.5 mm (0.31 to 0.73 in) and one M25 blanking plug.
- Terminal capacity 2 x 2.5 to 4 mm² (#14 to #12 AWG). Can be through-wired up to 4 mm² (#12 AWG).
- Fitted with two linked earth terminals.



Plug (LV)

- Integrated cable clamp – Ø 9.2 to Ø 17 mm (0.36 to 0.67 in).
- Terminal capacity 2.5 to 4 mm² (#14 to #12 AWG).

LV: Low Voltage

Yellow	Blue	Red	Black
100/130 Vac	200/250 Vac	380/415 Vac	480/500 Vac
			600/690 Vac















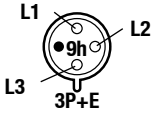

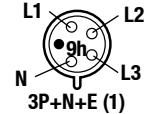
PLUGS AND RECEPTACLES: ATEX/IECEX FLAMEPROOF

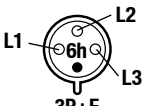
Appleton

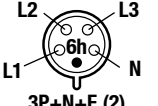
ATX™ UPR Series 16 Amp Plugs and Sockets

Increased Safety

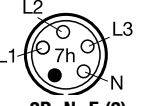
ATEX/IECEX:
 Zone 1 and 2 - 21 and 22
 II 2 GD
 IP66 - IK09

Description	Pin Configuration	Weight kg (lb)	Volume dm ³ (in ³)	Color	Catalog Number
Low Voltage: LV					
100/130 Vac 50/60 Hz - Yellow					
Wall Socket		1.29 (2.84)	11.30 (689.57)	Yellow	UPR316RY4
Plug		0.31 (0.68)	2.40 (146.46)	Yellow	UPR316PY4
200/250 Vac 50/60 Hz - Blue					
Wall Socket		1.29 (2.84)	11.30 (689.57)	Blue	UPR316RB6
Plug		0.31 (0.68)	2.40 (146.46)	Blue	UPR316PB6
Wall Socket		1.39 (3.06)	11.30 (689.57)	Blue	UPR416RB9
Plug		0.38 (0.84)	2.40 (146.46)	Blue	UPR416PB9
Wall Socket		1.43 (3.15)	11.30 (689.57)	Blue	UPR516RB9
Plug		0.41 (0.90)	2.40 (146.46)	Blue	UPR516PB9
	(1) 120/208 V - 144/250 Vac 50/60 Hz				
380/415 Vac 50/60 Hz - Red					
Wall Socket		1.39 (3.06)	11.30 (689.57)	Red	UPR416RR6
Plug		0.38 (0.84)	2.40 (146.46)	Red	UPR416PR6
Wall Socket		1.43 (3.15)	11.30 (689.57)	Red	UPR516RR6
Plug		0.41 (0.90)	2.40 (146.46)	Red	UPR516PR6
	(2) 200/346 V - 240/415 Vac 50/60 Hz				
480/500 Vac 50/60 Hz - Black					
Wall Socket		1.39 (3.06)	11.30 (689.57)	Black	UPR416RN7
Plug		0.38 (0.84)	2.40 (146.46)	Black	UPR416PN7
Wall Socket		1.43 (3.15)	11.30 (689.57)	Black	UPR516RN7
Plug		0.41 (0.90)	2.40 (146.46)	Black	UPR516PN7
	(3) 277/480-288/500 Vac 50/60Hz				

ATX™ UPR Series 16 Amp Plugs and Sockets

Increased Safety

ATEX/IECEX:
 Zone 1 and 2 - 21 and 22
 II 2 GD
 IP66 - IK09

Appleton®

PLUGS AND RECEPTACLES: ATEX/IECEX FLAMEPROOF

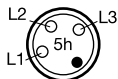
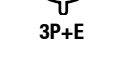
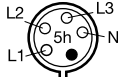
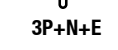
Description	Pin Configuration	Weight kg (lb)	Volume dm ³ (in ³)	Color	Catalog Number
Low Voltage: LV					
600/690 Vac 50/60 Hz - Black					
Wall Socket		1.39 (3.06)	11.30 (689.57)	Black	UPR416RN5
Plug		0.38 (0.84)	2.40 (146.46)	Black	UPR416PN5
Wall Socket		1.43 (3.15)	11.30 (689.57)	Black	UPR516RN5
Plug		0.41 (0.90)	2.40 (146.46)	Black	UPR516PN5

ATX™ UPR Series 16 Amp Plugs and Sockets

Increased Safety

ATEX/IECEX:
 Zone 1 and 2 - 21 and 22
 II 2 GD
 IP66 - IK09

Dimensions in Millimeters (Inches)

16A – 2P+E – 3P+E – 3P+N+E Versions

Wall Mounting Sockets

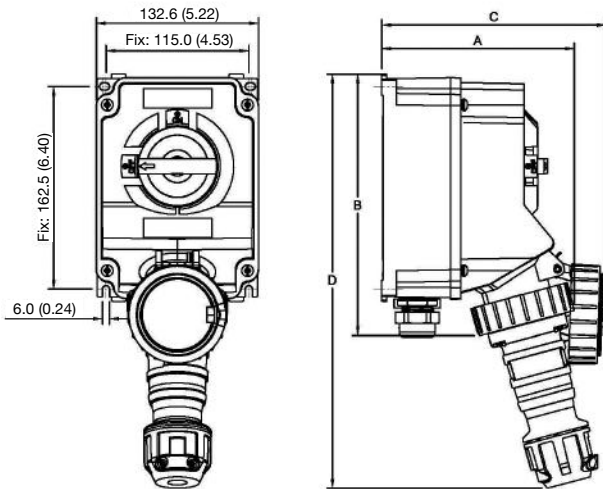

Plugs

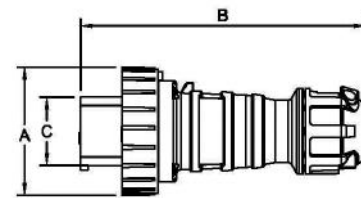

Dimensions in Millimeters (Inches)

	A	B	C	D
2 P + E	157.0 (6.18)	211.0 (8.31)	183.5 (7.22)	335.0 (13.19)
3 P + E	161.0 (6.34)	215.0 (8.47)	193.0 (7.60)	335.0 (13.19)
3 P + N + E	163.0 (6.42)	215.0 (8.47)	193.0 (7.60)	335.0 (13.19)

Dimensions in Millimeters (Inches)

	A	B	C
2 P + E	81.0 (3.19)	183.0 (7.20)	44.0 (1.73)
3 P + E	89.0 (3.50)	183.0 (7.20)	49.0 (1.93)
3 P + N + E	93.5 (3.68)	183.0 (7.20)	56.0 (2.20)